

SÃO VICENTE DO SUL

Sem Escala



MUNICÍPIO NO ESTADO

Sem Escala

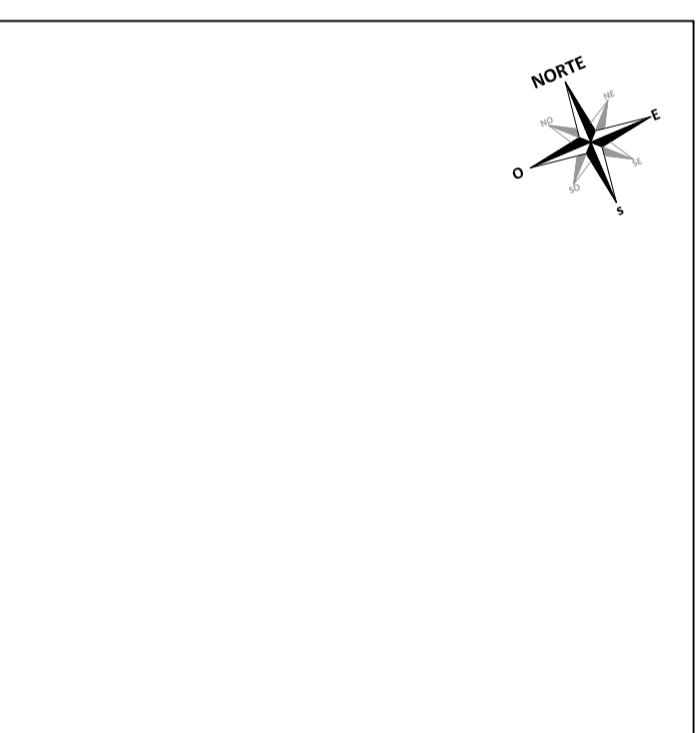
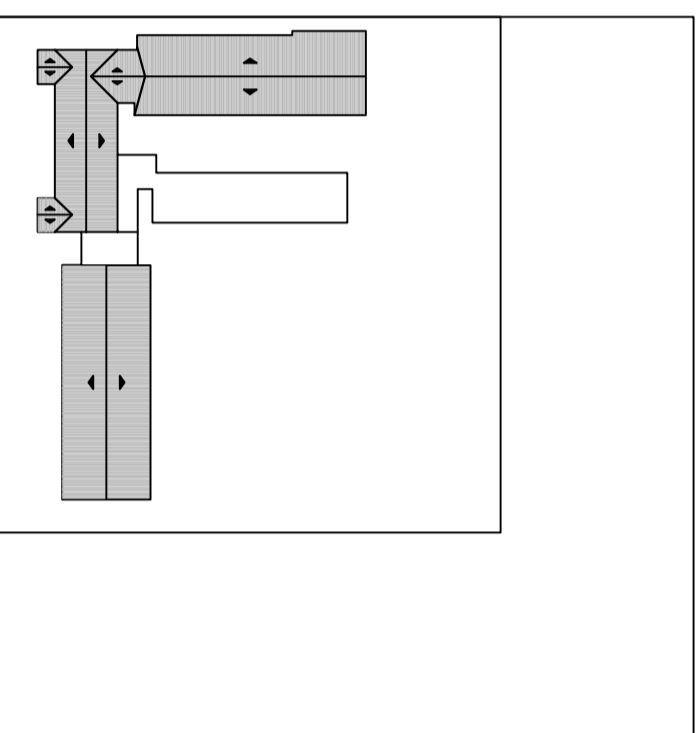
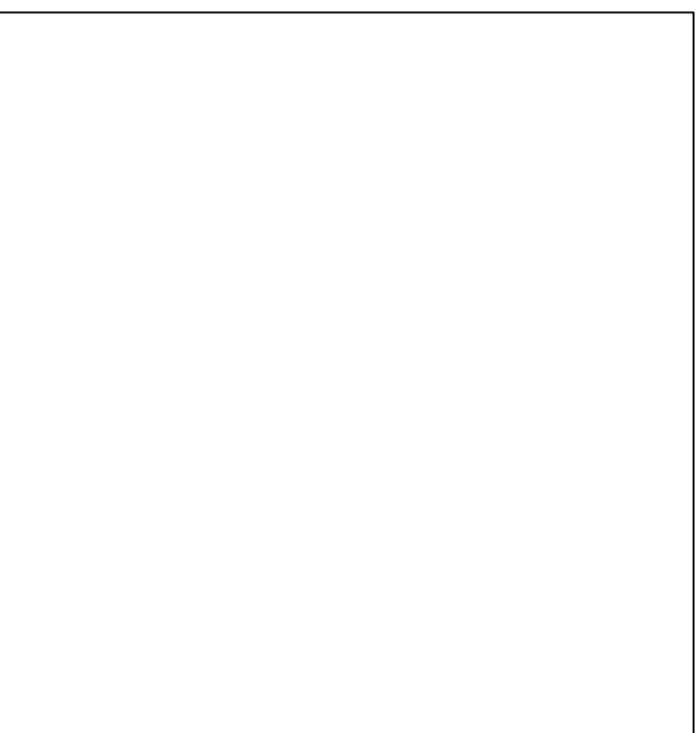

RUA SETE DE SETEMBRO

RUA ANTONIO GOMES

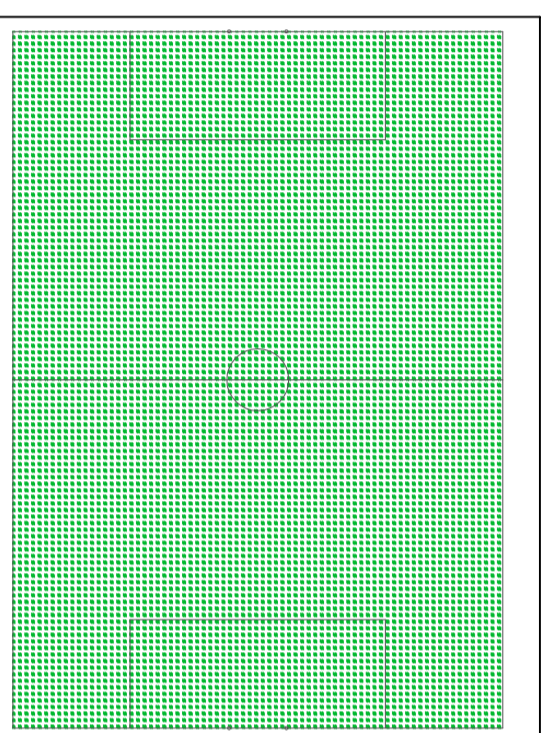

AV. DR. MANOEL CIPRIANO D'ÁVILA

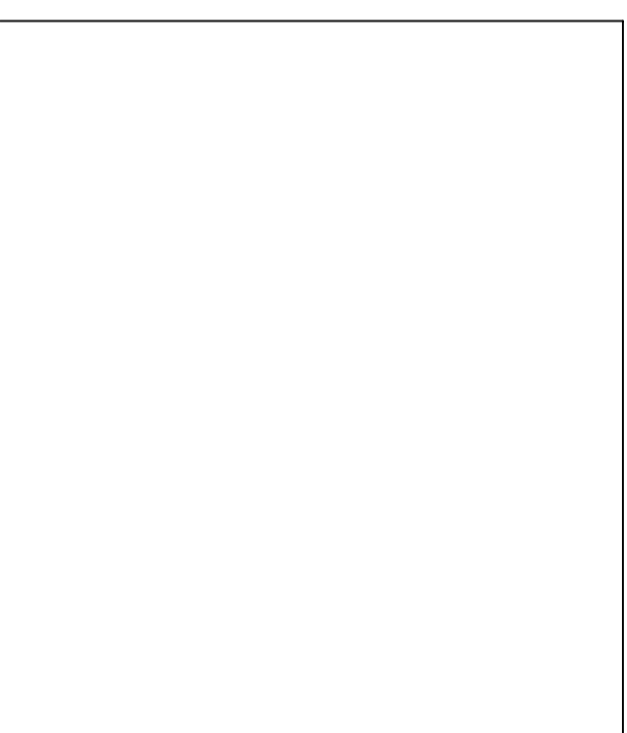
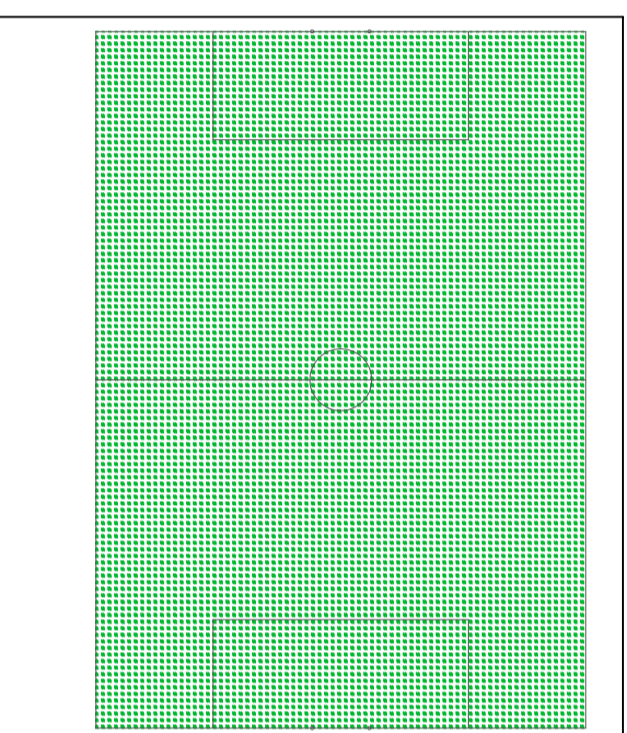
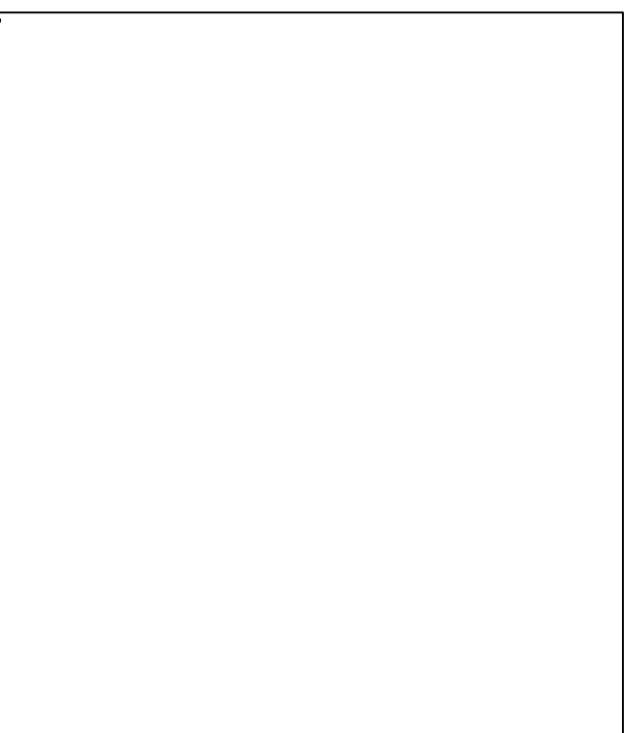

PLANTA DE SITUAÇÃO

Sem Escala



Prefeitura Municipal
São Vicente do Sul
 2017 - 2020
 Município desenvolvido, cidadão valorizado

PROJETO: **CONSULTA POPULAR 2017/2018**

LOCAL: **HOSPITAL SÃO VICENTE FERRER**

FRANQUIA: **SITUAÇÃO**

ÁREA: -

RESPONSÁVEL TÉCNICO:

FRANQUIA Nº: **01**